

Vibrating Fork Level Switches Manual

VRT Smart Type

■ English



■ Hookup

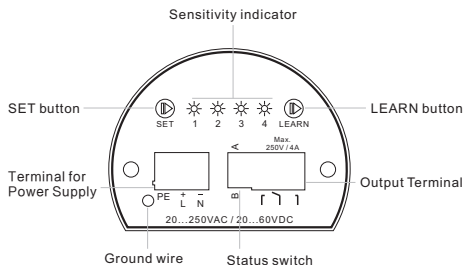

■ Mode of Connection

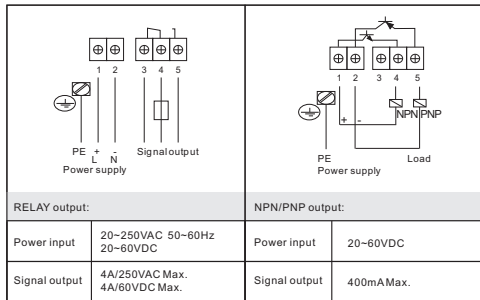

3

■ Manual

1. Unlock: Hold "SET" button, for 10 sec., until the four LED flash to status of unlock. After unlock, it is back to normal operating mode.
 2. Lock: It is automatically locked if there is no button pressed in 60 sec.
 3. NO/NC Setting: Press DIP switch to set NO or NC.
 4. Learn mode: Put fork part into the detected medium for 5 sec. and then operate "Unlock". After unlock, hold "LEARN" button for 5 sec., the LED1 ~ LED4 will flash orderly with frequency which is 1 time per sec. to start learning. If the four LEDs are all flash together, this learning is successful; if only the central two LEDs shine, this learning is failed and it is required to learn again.
 5. Sensitivity setting: Under status of unlock, press "SET" button to set sensitivity with checking the flash of LED1 to LED4. Sensitivity is from high to low by LED1 to LED4.
- Notice: To enter the second learning mode, please press "SET" button in 3 sec. after first learning finished. Otherwise the user shall be required to process the whole learning mode again to reset the setting. This function is to avoid of the false operation.

Notice:

1. The learning function of this type is not only to overcome the condition of the vibration absorption after the installation on the wall of tank but also to avoid of false operation caused by noise interference.
2. Factory setting is based on the density of water (1g/cm³). When the density of detected object is higher than or equal to 1g/cm³, it can be used normally without setting learning function. Otherwise it needs to reset learning function when the density of detected object is lower than 1g/cm³.
3. Sensitivity is set as the highest value in the factory and suitable to be used under the stable wave of medium. If the wave of medium fluctuates bigger, it is required to lower the sensitivity to avoid any error in warning.

■ Output of Switch2

Switch 2	A	B
RELAY OUT		
NPN OUT		
PNP OUT		
Indicator		

4

■ Technical Datasheet

Power supply	20...60VDC 20...250VAC RELAY output
	20...60VDC NPN&PNP output
Response time	< 3 seconds
Power-on delay	< 3 seconds Wait until the fork frequency is stable
Ambient Temperature	-40...+70°C
Storage Temperature	-40...+85°C
Medium Temperature	-40...+150°C
Operating pressure	-1...+40 bar
Detected substance	It can be applied to detect any kind of powder, granule, and liquid though the learning function
Mounting	G1½"A, Flange, Fixture
Socket	M20 x 1.5
Housing material	Alumimun Alloy
Fork material	Stainless steel 316L
Output	RELAY, Load AC250V/4A, DC60V/4A
	NPN, Load 400mA
	PNP, Load 400mA
Electricity	DC 3W Max. AC 15W Max.
EMC	ESD 6 kV
	EFT 2 kV
Protection classification	IP 67

■ Dimensions

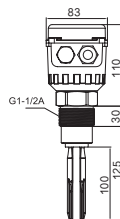

Unit: mm VRT10 Standard

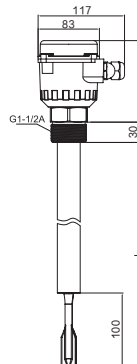

VRT11 Extension

■ Accessories

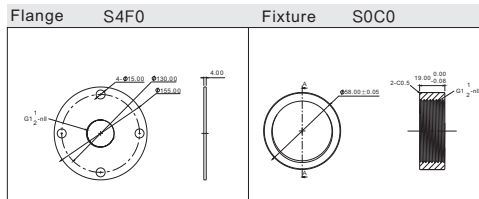

■ Installation

1. The ideal installation for reducing the shock to materials and the hanging of materials is to make the switch horizontal at an angle of 15-20°.
2. Keep the switches away from the feed opening of the barrel to reduce the shock to materials, if unavoidable, a protection plate is necessary.
3. The inlet of the connection box should be downward and the fixing nuts of power line must be tightened.
4. The operators cannot use vibration rod to climb or hook any object when working within the barrel.

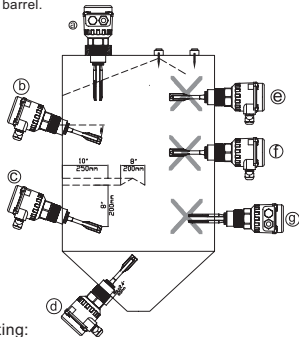

Correct mounting:

- a** Top-mounted
Fork is vertical towards bottom and mounted in any position far away from the feed opening of top side.
- b** Laterally mounted
Fork angled slightly downwards by 15~20 degree so as to reduce the shock and the hanging of the flowing materials.
- c** Laterally mounted with shield
With a shield, length approx. 10 in(250mm), width approx. 8 in(200mm), fork angled slightly downwards by 15~20 degree so as to reduce the shock of the flowing materials and prevent the improper stock from itself.
- d** In discharge hopper
Max. nozzle length 2.4 in (60mm), so that no build-up occurs which prevents the fork from oscillating.

Incorrect mounting:

- e** Laterally mounted in filling curtain or under the feed opening.
- f** Incorrect fork orientation
The surface of fork is subjected to high load caused by discharging material; It may cause false function due to residual material.
- g** The switch will not work normally when the distance of mounting nozzle and barrel is over 2.4"(60mm).

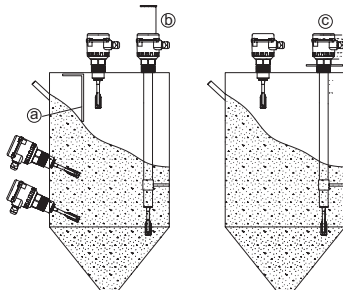

- a** Shield to protect against flowing material.
- b** Sufficient space for mounting and for adjusting.
- c** Protective hood against condensation in the housing.

EX Fork Level Switches Manual

VRE Smart Type

■ English



www.ema-electronic.com

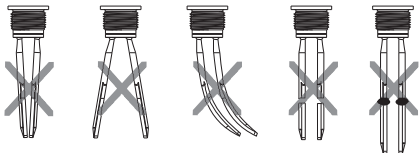

Do not:
damage the fork; bend the fork; shorten the fork; and lengthen the fork.

• Mark on the hex nut.

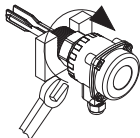

The top of the fork is marked.

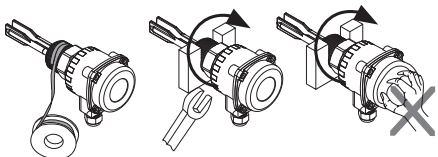

Enclosed by PTFE
thread seal tape.

Tightened by a
wrench.

Not wrested
by hands.

■ Description

1. Introduction

This product could control the level of solid for bulk, pellet, powder or the alarm of up and low level. It is suitable for harsh environment such as high pressure, strong and dusty area. It is widely used in metallurgy, petroleum, chemical industry, light industry, colliery, cement and food industry.

This Ex-proof product is verified and certified according to standard(s) for safety as below: GB3836.1-2010 Explosive atmospheres Part 1: Equipment-General requirements GB3836.2-2010 Explosive atmospheres Part 2: Equipment protection by flameproof enclosures "d". The Ex-proof marking: ExdIICT6. It is suitable for the explosive gases and mixture endangered places that included IIA~IIC, temperature is from T1 to T6.

This Ex-proof product is verified and certified according to standard(s) for safety as below: GB/T 12476.1-2013 Electrical Apparatus for Use in the Presence of Combustible Dust - Part 1: General Requirements (IEC 61241-0:2004: MOD) and GB/T12476.5-2013 Electrical Apparatus for Use in the Presence of Combustible Dust - Part 5: Protection by Enclosures "tD". The Ex-proof marking: Ex tD A20/A21 IP66 T100°C. It is used in Zone 20/21. Max. surface temperature is 100°C for use in the presence of combustible dust in hazardous area.

■ Ordering no.

The level switches ordering and Ex-proof marks:

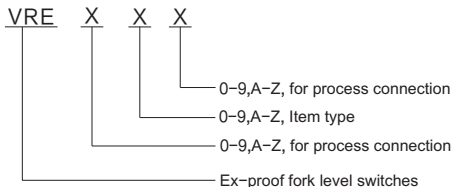

2. Order information

■ Atmospheres:

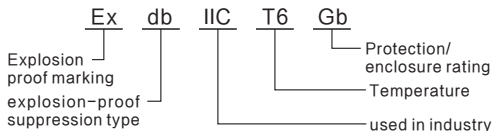

■ Dust:

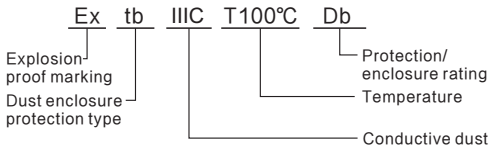

■ Hookup

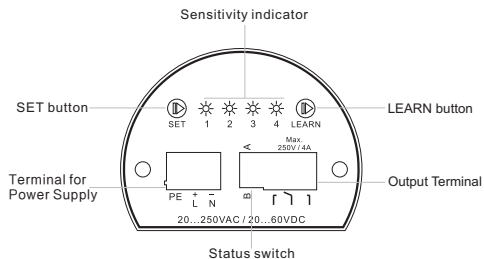

■ Mode of Connection

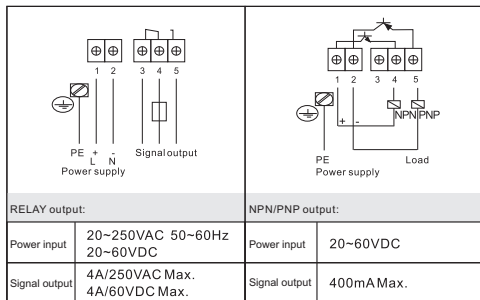

■ Manual

1. **Unlock**: Hold "SET" button, for 10 sec., until the four LED flash to status of unlock. After unlock, it is back to normal operating mode.
 2. **Lock**: It is automatically locked if there is no button pressed in 60 sec.
 3. **NO/NC Setting**: Press DIP switch to set NO or NC.
 4. **Learn mode**: Put fork part into the detected medium for 5 sec. and then operate "Unlock". After unlock, hold "LEARN" button for 5 sec., the LED1 ~ LED4 will flash orderly with frequency which is 1 time per sec. to start learning. If the four LEDs are all flash together, this learning is successful; if only the central two LEDs shine, this learning is failed and it is required to learn again.
 5. **Sensitivity setting**: Under status of unlock, press "SET" button to set sensitivity with checking the flash of LED1 to LED4. Sensitivity is from high to low by LED1 to LED4.
- Notice**: To enter the second learning mode, please press "SET" button in 3 sec. after first learning finished. Otherwise the user shall be required to process the whole learning mode again to reset the setting. This function is to avoid of the false operation.

Notice:

1. The learning function of this type is not only to overcome the condition of the vibration absorption after the installation on the wall of tank but also to avoid of false operation caused by noise interference.
2. Factory setting is based on the density of water (1g/cm³). When the density of detected object is higher than or equal to 1g/cm³, it can be used normally without setting learning function. Otherwise it needs to reset learning function when the density of detected object is lower than 1g/cm³.
3. Sensitivity is set as the highest value in the factory and suitable to be used under the stable wave of medium. If the wave of medium fluctuates bigger, it is required to lower the sensitivity to avoid any error in warning.

■ Output of Switch2

Switch 2	A	B
RELAY OUT		
NPN OUT		
PNP OUT		
Indicator	⊗	☀

■ Technical Datasheet

Power supply	20...60VDC 20...250VAC RELAY output
	20...60VDC NPN&PNP output
Response time	< 3 seconds
Ambient Temperature	-40...+70°C
Storage Temperature	-40...+85°C
Medium Temperature	-40...+150°C
Operating pressure	-1...+40 bar
Detected substance	It can be applied to detect any kind of powder, granule, and liquid though the learning function
Mounting	G1½" A, Flange, Fixture
Socket	M20 x 1.5
Housing material	Alumimun Alloy
Fork material	Stainless steel 316L
Output	RELAY, Load AC250V/4A, DC60V/4A
	NPN, Load 400mA
	PNP, Load 400mA
Electricity	DC 3W Max. AC 15W Max.
	ESD 6 kV
EMC	EFT 2 kV
EX-proof marking	Ex db IIC T6 Gb / Ex tb IIIC T100°C Db
Protection classification	IP 66

■ Dimensions

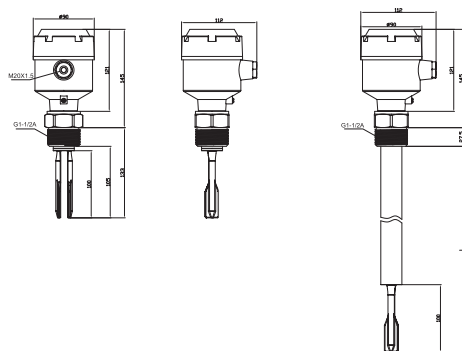

Unit: mm VRE10 Standard

VRE11 Extension

■ Accessories

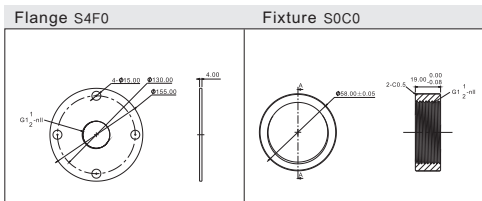

■ Installation

1. The ideal installation for reducing the shock to materials and the hanging of materials is to make the switch horizontal at an angle of 15-20.
2. Keep the switches away from the feed opening of the barrel to reduce the shock to materials, if unavoidable, a protection plate is necessary.
3. The inlet of the connection box should be downward and the fixing nuts of power line must be tightened.
4. The operators cannot use vibration rod to climb or hook any object when working within the barrel.

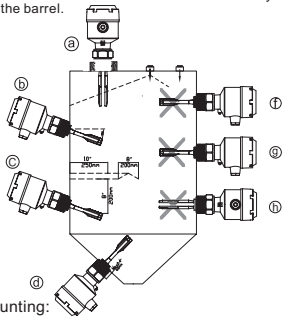

④ Correct mounting:

- ④ Top-mounted
Fork is vertical towards bottom and mounted in any position far away from the feed opening of top side.
- ④ Laterally mounted
Fork angled slightly downwards by 15~20 degree so as to reduce the shock and the hanging of the flowing materials.
- ④ Laterally mounted with shield
With a shield, length approx. 10 in(250mm), width approx. 8 in(200mm), fork angled slightly downwards by 15~20 degree so as to reduce the shock of the flowing materials and prevent the improper stock from itself.
- ④ In discharge hopper
Max. nozzle length 2.4 in (60mm), so that no build-up occurs which prevents the fork from oscillating.
- ④ To ensure the seal, the entrance of cable diameter \geq 8mm

Incorrect mounting:

- ④ Laterally mounted in filling curtain or under the feed opening.
- ④ Incorrect fork orientation
- ④ The surface of fork is subjected to high load caused by discharging material; It may cause false function due to residual material.
- ④ The switch will not work normally when the distance of mounting nozzle and barrel is over 2.4"(60mm).

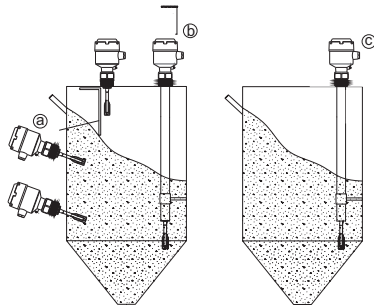

- ④ Shield to protect against flowing material.
- ④ Sufficient space for mounting and for adjusting.
- ④ Protective hood against condensation in the housing.

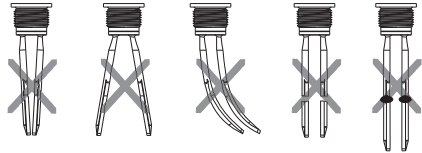

Do not:
damage the fork; bend the fork; shorten the fork; and lengthen the fork.

• Mark on the hex nut.

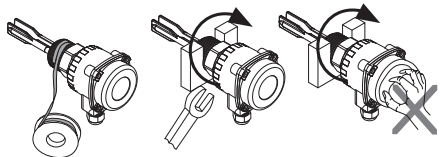
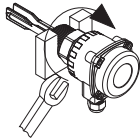

Enclosed by PTFE
thread seal tape.

Tightened by a
wrench.

Not wrested
by hands.

Vibrating Fork Level Switches Manual

VRM10/VRM11

■ English



www.ema-electronic.com

Hookup

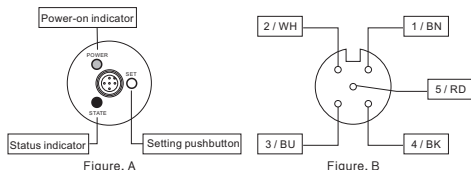

Mode of Connection

<p>NPN</p> <p>Red LED OFF</p>	<p>PNP</p> <p>Red LED flashes</p>	<p>NPN/PNP output:</p> <p>Power input 20~60VDC</p> <p>Signal output 200mA Max.</p>
<p>RELAY</p>		

Manual

1. Unlock: "SET" button for 10 secs until alternate red and green lights flash. The unit unlocks and returns to the operation mode. The red and green light stop flashing when "SET" button is released.
2. Lock: It is automatically locked when there is no operation within 60 secs.
3. NO / NC setting: Under the unlock condition, hold "SET" button for 3 secs and then the alternate red and green lights flash. When the green LED flashes, release the button to enter NO / NC setting mode and then press "SET" button once to adjust the required status.

4. Learning mode: Put the fork part into the detected medium with stability for 5 secs. Under the unlock condition, hold "SET" button for 3 secs and then the alternate red and green lights flash. When the red LED flashes, release the button. The red LED flashes once in a second orderly to express the status of waiting for learning. Then, press "SET" button, and the red LED flashes and goes out twice to express the status of learning. The learning setting is successfully finished when the alternate red and green lights flash quickly. Otherwise, the red and green light flashes together and the user has to set the learning function again. To reset the learning, just press "SET" button again to enter second learning mode.







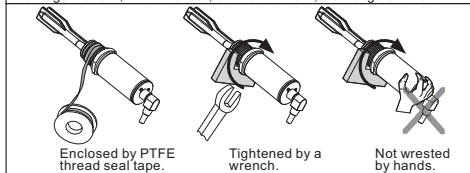
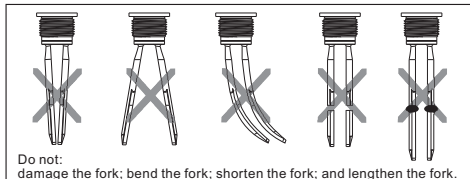





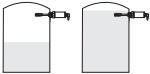

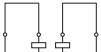
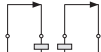

Note: To enter the second learning mode, please press "SET" button in 3 sec. after first learning finished. Otherwise the user shall be required to process the whole learning mode again to reset the setting. This function is to avoid of the false operation.

Note:

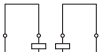
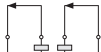
1. The learning function of this type is not only to overcome the condition of the vibration absorption after the installation on the wall of tank but also to avoid of false operation caused by noise interference.
2. factory setting is based on the density of water (1g/cm³). When the density of detected object is higher than or equal to 1g/cm³, it can be used normally without setting learning function. Otherwise it needs to reset learning function when the density of detected object is lower than 1g/cm³.



■ Status Indicators

		 	
Maximum			
			
			
Minimum			
			
			
		 : Green LED: Power on/off  : Red LED: Operation  : Setting pushbutton	

■ Technical Datasheet

Power supply	20...60VDC	20...250VAC	50...60Hz
Response time	< 3 seconds		
Ambient Temperature	-40...+70°C		
Storage Temperature	-40...+85°C		
Medium Temperature	-40...+130°C(150/1H MAX)		
Operating pressure	-1...+40bar		
Detected substance	It can be applied to detect any kind of powder, granule, and liquid though the learning function		
Connection	G1"A		
Socket	M12 × P1.0 adaptor		
Housing material	Stainless steel 304		
Fork material	Stainless steel 316L		
Output	RELAY, Load AC250V/4A, DC60V/4A		
	NPN, Load 200mA		
	PNP, Load 200mA		
Electricity	DC 3W Max. AC 15W Max.		

■ Installation

1. The ideal installation for reducing the shock to materials and the hanging of materials is to make the switch horizontal at an angle of 15-20.
2. Keep the switches away from the feed opening of the barrel to reduce the shock to materials, if unavoidable, a protection plate is necessary.
3. The inlet of the connection box should be downward and the fixing nuts of power line must be tightened.
4. The operators cannot use vibration rod to climb or hook any object when working within the barrel.

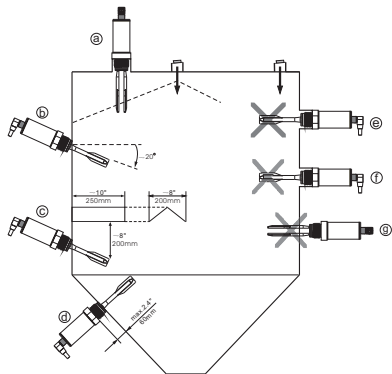

Correct mounting:

- Ⓐ Top-mounted
Fork is vertical towards bottom and mounted in any position far away from the feed opening of top side.
- Ⓑ Laterally mounted
Fork angled slightly downwards by 15-20 degree so as to reduce the shock and the hanging of the flowing materials.
- Ⓒ Laterally mounted with shield
With a shield, length approx. 10" (250mm), width approx. 8" (200mm), fork angled slightly downwards by 15-20 degree so as to reduce the shock of the flowing materials and prevent the improper stock from itself.
- Ⓓ In discharge hopper
Max. nozzle length 2.4" (60mm), so that no build-up occurs which prevents the fork from oscillating.

Incorrect mounting:

- Ⓔ Laterally mounted in filling curtain or under the feed opening.
- Ⓕ Incorrect fork orientation
The surface of fork is subjected to high load caused by discharging material, it may cause false function due to residual material.
- Ⓖ The switch will not work normally when the distance of mounting nozzle and barrel is over 2.4" (60mm).

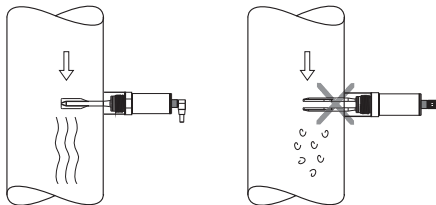
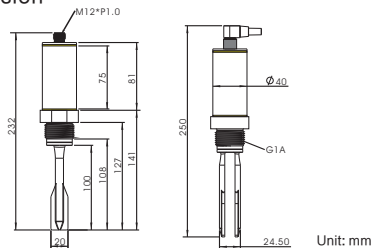

Figure: Mounting of VRM into the pipe. Left one is correct, but Right one is incorrect.

■ Dimension



■ Accessories Specifications



M12 Cable connection

Flange

Fixture

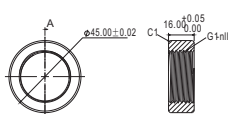
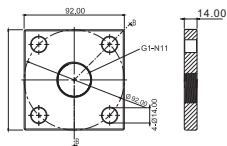

■ Adapter Dimensions

Hygienic welding adapter US0065:

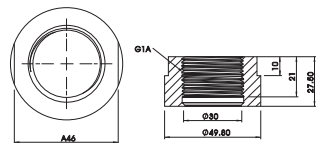

Unit: mm

Hygienic Tri Clamp adapter US0066:

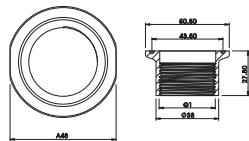

Unit: mm

Vibrating Fork Level Switches Manual

VRM20/VRM21

■ English

www.ema-electronic.com

■ Hookup

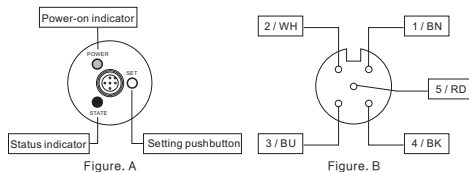

■ Mode of Connection

<p>NPN</p> <p>Red LED OFF</p>	<p>PNP</p> <p>Red LED flashes</p>	<p>NPN/PNP output:</p> <table border="1"> <tr> <td>Power input</td> <td>20~60VDC</td> </tr> <tr> <td>Signal output</td> <td>200mA Max.</td> </tr> </table>	Power input	20~60VDC	Signal output	200mA Max.
Power input	20~60VDC					
Signal output	200mA Max.					
<p>RELAY</p>		<p>RELAY output:</p> <table border="1"> <tr> <td>Power input</td> <td>20~250VAC 20~60VDC</td> </tr> <tr> <td>Signal output</td> <td>4A/250VAC Max. 4A/60VDC Max.</td> </tr> </table>	Power input	20~250VAC 20~60VDC	Signal output	4A/250VAC Max. 4A/60VDC Max.
Power input	20~250VAC 20~60VDC					
Signal output	4A/250VAC Max. 4A/60VDC Max.					

■ Operation

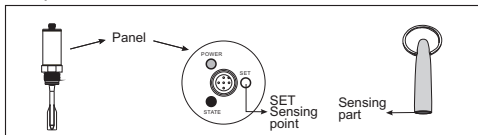

Manual

1. Unlock: "SET" button for 10 secs until alternate red and green lights flash. The unit unlocks and returns to the operation mode. The red and green light stop flashing when "SET" button is released.
2. Lock: It is automatically locked when there is no operation within 60 secs.
3. NO / NC setting: Under the unlock condition, hold "SET" button for 3 secs and then the alternate red and green lights flash. When the green LED flashes, release the button to enter NO / NC setting mode and then press "SET" button once to adjust the required status.
4. Learning mode: Put the fork part into the detected medium with stability for 5 secs. Under the unlock condition, hold "SET" button for 3 secs and then the alternate red and green lights flash. When the red LED flashes, release the button. The red LED flashes once in a second orderly to express the status of waiting for learning. Then, press "SET" button, and the red LED flashes and goes out twice to express the status of learning. The learning setting is successfully finished when the alternate red and green lights flash quickly. Otherwise, the red and green light flashes together and the user has to set the learning function again. To reset the learning, just press "SET" button again to enter second learning mode.

Notice: To enter the second learning mode, please press "SET" button in 3 sec. after first learning finished. Otherwise the user shall be required to process the whole learning mode again to reset the setting.
This function is to avoid of the false operation.

Notice:

1. The learning function of this type is not only to overcome the condition of the vibration absorption after the installation on the wall of tank but also to avoid of false operation caused by noise interference.
2. factory setting is based on the density of water (1g/cm³). When the density of detected object is higher than or equal to 1g/cm³, it can be used normally without setting learning function. Otherwise it needs to reset learning function when the density of detected object is lower than 1g/cm³.

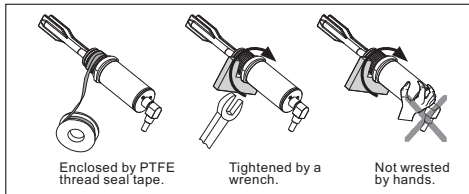
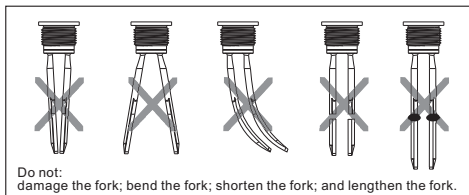

■ Status Indicators

Maximum		
Minimum		
		<p> : Green LED: Power on/off</p> <p> : Red LED: Operation</p> <p> : Setting pushbutton</p>

Power supply	20...60VDC	20...250VAC	50...60Hz
Response time	< 3 seconds		
Ambient Temperature	-40...+70°C		
Storage Temperature	-40...+85°C		
Medium Temperature	-40...+130°C(150/1H MAX)		
Operating pressure	-1...+40bar		
Detected substance	It can be applied to detect any kind of powder, granule, and liquid though the learning function		
Connection	G1" A		
Socket	M12 x P1.0 adaptor		
Housing material	Stainless steel 304		
Fork material	Stainless steel 316L		
Output	RELAY, Load AC250V/4A, DC60V/4A		
	NPN, Load 200mA		
	PNP, Load 200mA		
Electricity	DC 3W Max. AC 15W Max.		

■ Installation

1. The ideal installation for reducing the shock to materials and the hanging of materials is to make the switch horizontal at an angle of 15-20.
2. Keep the switches away from the feed opening of the barrel to reduce the shock to materials, if unavoidable, a protection plate is necessary.
3. The inlet of the connection box should be downward and the fixing nuts of power line must be tightened.
4. The operators cannot use vibration rod to climb or hook any object when working within the barrel.

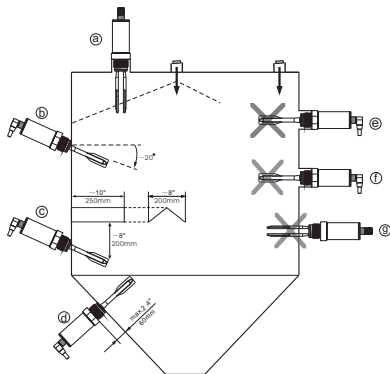

Correct mounting:

- (a) Top-mounted
Fork is vertical towards bottom and mounted in any position far away from the feed opening of top side.
- (b) Laterally mounted
Fork angled slightly downwards by 15-20 degree so as to reduce the shock and the hanging of the flowing materials.
- (c) Laterally mounted with shield
With a shield, length approx. 10"(250mm), width approx. 8"(200mm), fork angled slightly downwards by 15-20 degree so as to reduce the shock of the flowing materials and prevent the improper stock from itself.
- (d) In discharge hopper
Max. nozzle length 2.4" (60mm), so that no build-up occurs which prevents the fork from oscillating.

Incorrect mounting:

- (e) Laterally mounted in filling curtain or under the feed opening.
- (f) Incorrect fork orientation
The surface of fork is subjected to high load caused by discharging material, it may cause false function due to residual material.
- (g) The switch will not work normally when the distance of mounting nozzle and barrel is over 2.4"(60mm).

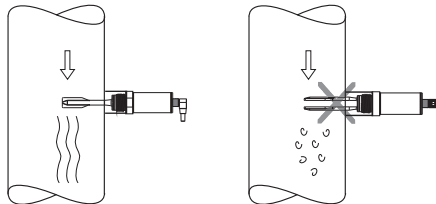
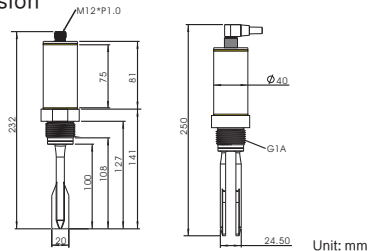

Figure: Mounting of VRM into the pipe. Left one is correct, but Right one is incorrect.

Dimension



Accessories Specifications



M12 Cable connection

Flange

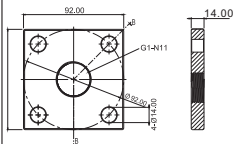

Fixture

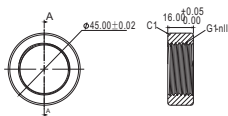

Adapter Dimensions

Hygienic welding adapter US0065:

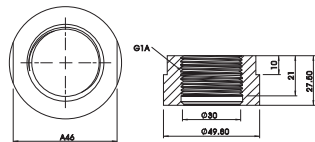

Unit: mm

Hygienic Tri Clamp adapter US0066:

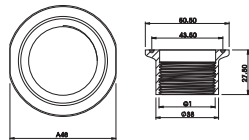

Unit: mm

Stainless Steel Vibrating Fork Level Switches Manual

VRS Mini Type

English



www.ema-electronic.com

Hookup

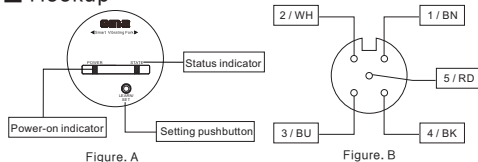

Mode of Connection

RELAY BN+ RD BK WH BU-	RELAY output:	
	Power input	18~36VDC
	Loading	DC/AC 36V/1A
NPN BK BN+ WH BU- RD Red LED goes out	PNP BK BN+ WH BU- RD Red LED flashes	NPN/PNP output:
	Power input	18~36VDC
	Loading	200mA Max.

NPN/PNP output WH: ⊕ Ground connection

Manual

1. Unlock: "SET" button for 10 secs until alternate red and green lights flash. The unit unlocks and returns to the operation mode. The red and green light stop flashing when "SET" button is released.
2. Lock: It is automatically locked when there is no operation within 60 secs.
3. NO / NC setting: Under the unlock condition, hold "SET" button for 3 secs and then the alternate red and green lights flash. When the green LED flashes, release the button to enter NO / NC setting mode and then press "SET" button once to adjust the required status.

4. Learning mode: Put the fork part into the detected medium with stability for 5 secs. Under the unlock condition, hold "SET" button for 3 secs and then the alternate red and green lights flash. When the red LED flashes, release the button. The red LED flashes once in a second orderly to express the status of waiting for learning. Then, press "SET" button, and the red LED flashes and goes out twice to express the status of learning. The learning setting is successfully finished when the alternate red and green lights flash quickly. Otherwise, the red and green light flashes together and the user has to set the learning function again. To reset the learning, just press "SET" button again to enter second learning mode.

Notice: To enter the second learning mode, please press "SET" button in 3 sec. after first learning finished. Otherwise the user shall be required to process the whole learning mode again to reset the setting. This function is to avoid of the false operation.

Notice:

1. The learning function of this type is not only to overcome the condition of the vibration absorption after the installation on the wall of tank but also to avoid of false operation caused by noise interference.
2. factory setting is based on the density of water (1g/cm³). When the density of detected object is higher than or equal to 1g/cm³, it can be used normally without setting learning function. Otherwise the user shall be required to reset learning function when the density of detected object is lower than 1g/cm³.
3. When there are different media on site, it is necessary to learn the media separately according to individual media.

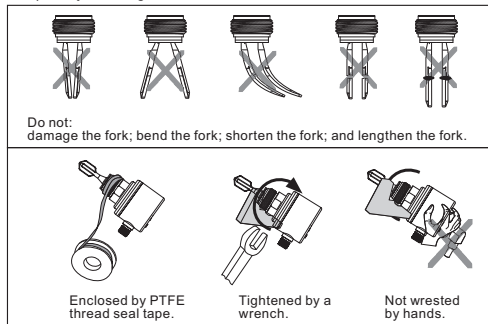

■ Status Indicators

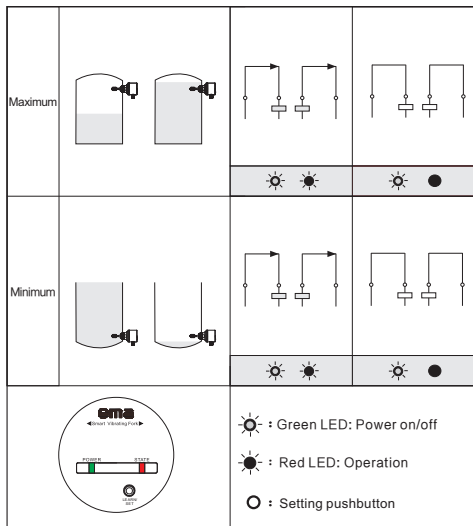

■ Technical Datasheet

Type	VRS10	VRS20
Power supply	18...36VDC	
Response time	< 1 second	
Ambient Temperature	-40...+70°C/-40...+158°F	
Storage Temperature	-40...+85°C/-40...+185°F	
Medium Temperature	-40...+100°C/ -40...+212°F	-40...+120°C/-40...+248°F (145°C max 1h)
Operating pressure	-1...+40bar	
Detected substance	It can be used to detect any kind of powder, granule, and liquid via the learning function	
Mounting	G¾"A	
Socket	M12 Socket	
Housing material	Stainless steel 316L	
Fork material	Stainless steel 316L	
Output	RELAY, Loading DC/AC 36V/1A NPN/PNP, Load 200mA	
Consumption	<1W (PNP/NPN)	
	<2W (RELAY)	
Protection	IP68	IP69K

■ Installation

1. The ideal installation for reducing the shock to materials and the hanging of materials is to make the switch horizontal at an angle of 15-20°.
2. Keep the switches away from the feed opening of the barrel to reduce the shock to materials, if unavoidable, a protection plate is necessary.
3. The inlet of the connection box should be downward and the fixing nuts of power line must be tightened.
4. The operators cannot use vibration rod to climb or hook any object when working within the barrel.

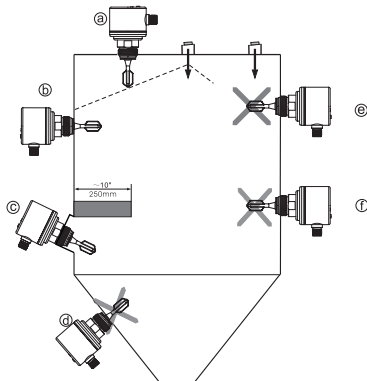

Correct mounting:

- Ⓐ Top-mounted
Fork is vertical towards bottom and mounted in any position far away from the feed opening of top side. Foam do not affect the Fork switch.
- Ⓑ Laterally mounted
To reduce the shock and the hanging of the flowing materials.
- Ⓒ Laterally mounted with shield
length approx. 10 in (250mm), width approx. 8 in (200mm), to reduce the shock of the flowing materials and prevent the improper stock from itself.
- Ⓓ In discharge hopper
Max. nozzle length 2.4 in (60mm), so that no build-up occurs which prevents the fork from oscillating.

Incorrect mounting:

- Ⓔ Laterally mounted in filling curtain or under the feed opening.
- Ⓕ Incorrect fork orientation
The surface of fork is subjected to high load caused by discharging material, It may cause false function due to residual material.

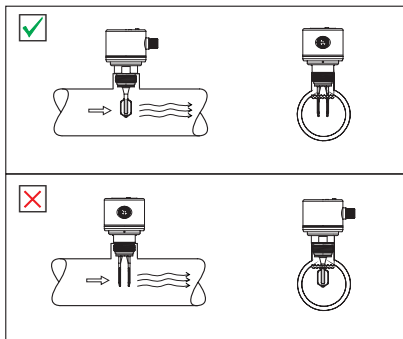

Installation in pipe:

- 5. Pay attention to the position of the fork and liquid direction.
- 6. If used as the alarm for empty pipe, to ensure that the fluid is fully filled inside in the pipe, so that the liquid can completely cover the fork.

Incorrect mounting:

- Ⓖ The level switch cannot be installed on the bent pipe to avoid the fluid not being able to fill the pipe and causing the level switch unstable status.
- Ⓗ Do not install in the area where pumps, valves, or other inlet are located.

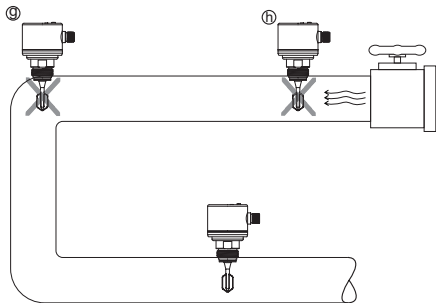

■ Dimensions

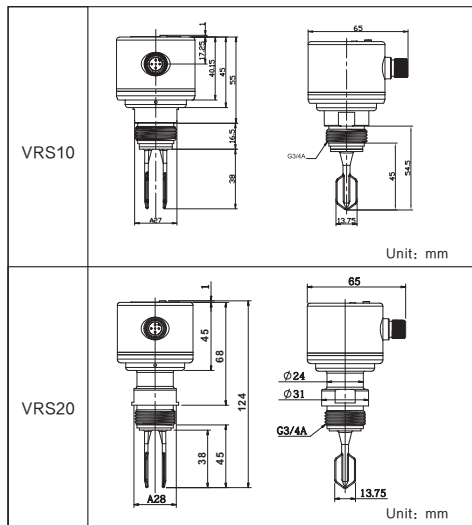

■ Welding adapter for sanitary sensors US0061

Dimensions

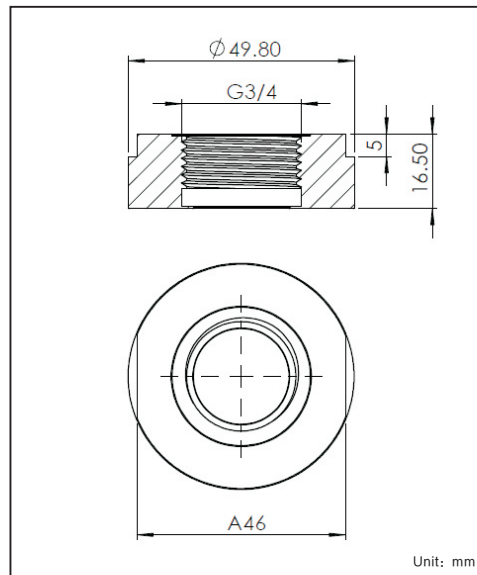



- The welding operation must be carried out by authorised personnel.
- It must be carried out carefully and according to state-of-the-art technology.
- During welding and the following cooling phase the sensor must not be in place.
- The surfaces must be free from any soiling.
- Welding tools must be suitable for the adapter and wall material.

1. Preparations

- ▶ Bore a hole in the pipe or housing wall with the external diameter of the adapter (max. oversize: 0.2 mm).
- ▶ If possible, screw a cover plug into the adapter.

2. Welding operation



The power of the welding device must be adapted to the thickness of the wall.

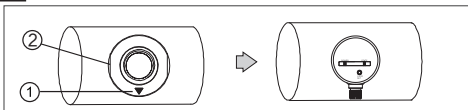

▶ Adapter alignment:

- ① to the marking ▼ for front display of the sensor.
- ② position for the spanner.

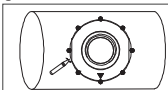

▶ Fix the adapter at several points with sufficient holding force. Apply the fixing points at equal distance opposite each other.

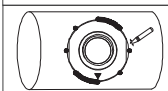

▶ Apply the welding seams between the fixing points opposite each other. Ensure sufficient intervals between the individual sections (cooling phases to avoid glowing through / warping of the adapter due to overheating).

3. After welding

- ▶ Let the adapter cool down.
- ▶ Clean the thread from welding residues.

4. Installation of Welding adapter for sanitary fork

	<ul style="list-style-type: none"> ▶ Check (A) and (C) if there is an O-ring. Do not install it without any of O-ring. ▶ Grease the sensor thread with lubricating paste (B). The paste must be suitable and approved for the application and compatible with the elastomers used. ▶ Screw the sensor into the adapter. Avoid damage to the sealing areas. <p>Note: If the sensor can only be screwed into the thread with great resistance, stop the force. If it is not possible to rectify the thread, remove the adapter and weld in a new one.</p>
	<ul style="list-style-type: none"> ▶ Tighten the sensor by a spanner until you can feel the end stop (this corresponds to a maximum tightening torque of 35 Nm). <p>Note: Further tightening may affect the sealing effect.</p>

■ Clamp adapter for sanitary sensors US0062

Dimensions

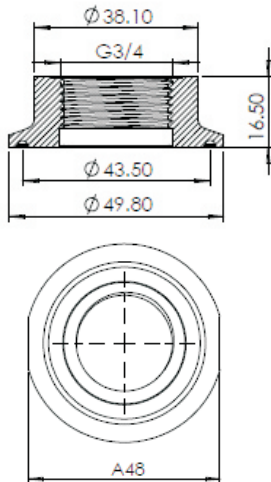

Unit: mm

1. Installation of Clamp adapter for sanitary temperature sensor

	<ul style="list-style-type: none"> ▶ Check (A) and (C) if there is an O-ring. Do not install it without any of O-ring. ▶ Grease the sensor thread with lubricating paste (B). The paste must be suitable and approved for the application and compatible with the elastomers used. ▶ Screw the sensor into the adapter. Avoid damage to the sealing areas. <p>Note: If the sensor can only be screwed into the thread with great resistance, stop the force. If it is not possible to rectify the thread, remove the adapter and weld in a new one.</p>
	<ul style="list-style-type: none"> ▶ Clamp the sensor + adapter into a clamping device. Tighten the clamping part slightly so that the adapter does not warp. ▶ Tighten the sensor by a spanner until you can feel the end stop (this corresponds to a maximum tightening torque of 35 Nm). <p>Note: Further tightening may affect the sealing effect.</p>

2. Install the connection

- Fix the sensor + adapter are fixed to the process connection by a fixing part (coupling nut, clamp adapter, etc.).
- If it is not possible to slide the fixing part down over the top of the unit: slide it up over the bottom of the unit before the adapter is mounted.